

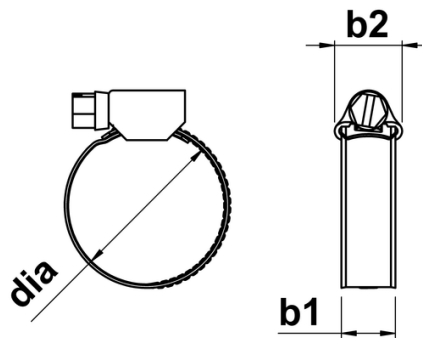

Hose Clips DIN 3017 9mm band in A4 Stainless Steel

The standard DIN 3017 non-perforated, worm drive hose clip. Perhaps the most popular hose clip currently in use worldwide. A sympathetic design helps guard against hose impingement and the smooth low friction worm drive allows for a strong clamping force. This version has a 9mm band width, for use where a less bulky hose clip is required, and is manufactured from A4 grade stainless steel.



band width (b1)	9mm
maximum housing width (b2)	14mm
material	A4 stainless steel